

**PRESS FIT PLUG RECEPTACLE
WITH CYLINDRICAL CONTACT**

R128.595.827

Series : BMA-COM

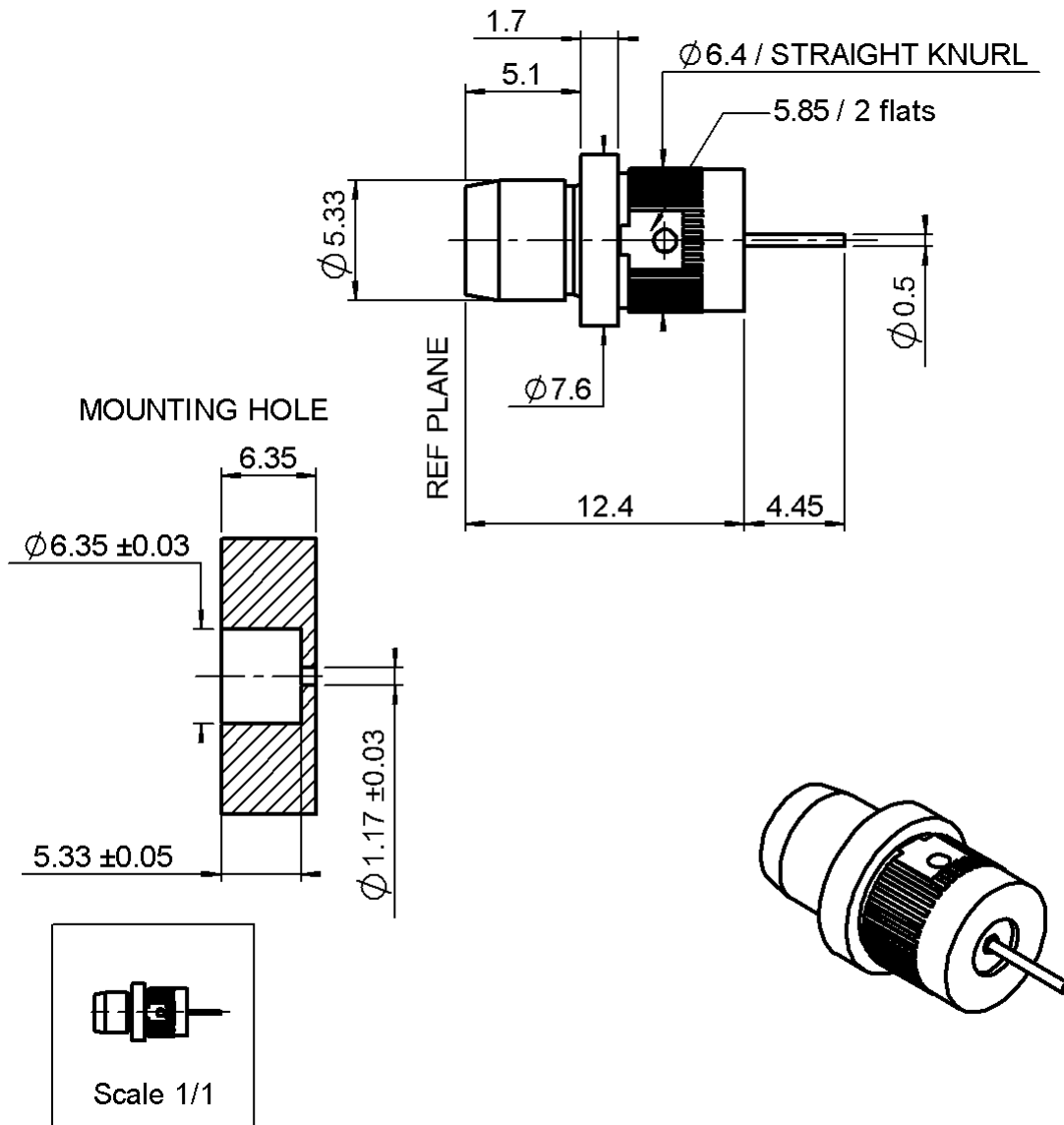

All dimensions are in mm.



COMPONENTS	MATERIALS	PLATINGS (µm)
BODY	BRASS	BBR 2
CENTER CONTACT	BRASS	GOLD 1.3 OVER COPPER 2
OUTER CONTACT	-	-
INSULATOR	PTFE	-
GASKET	-	-
OTHERS PARTS	-	-
-	-	-
-	-	-

Issue : 0102 A

In the effort to improve our products, we reserve the right to make changes judged to be necessary.



**PRESS FIT PLUG RECEPTACLE
WITH CYLINDRICAL CONTACT**

R128.595.827

Series : **BMA-COM**

PACKAGING

SPECIFICATION

Standard	Unit	Other
100	'W' option	Contact us

ELECTRICAL CHARACTERISTICS

Impedance		50 Ω
Frequency		0-22 GHz
VSWR	1.25* +	0.000 x F(GHz) Maxi
Insertion loss		0.07 √F(GHz) dB Maxi
RF leakage	- (90 - F(GHz)) dB Maxi
Voltage rating		500 Veff Maxi
Dielectric withstanding voltage		1500 Veff mini
Insulation resistance		5000 MΩ mini

ENVIRONMENTAL

Operating temperature	-65/+125 °C
Hermetic seal	NA Atm.cm ³ /s
Panel leakage	NA

OTHERS CHARACTERISTICS

Assembly instruction **NA**

Others :

* From 0 to 10 GHz

MECHANICAL CHARACTERISTICS

Center contact retention		
Axial force – Mating end	27	N mini
Axial force – Opposite end	27	N mini
Torque	NA	N.cm mini
Recommended torque		
Mating	NA	N.cm
Panel nut	NA	N.cm
Mating life	500	Cycles mini
Weight	1.988	g

Issue : **0102 A**

In the effort to improve our products, we reserve the right to make changes judged to be necessary.

